

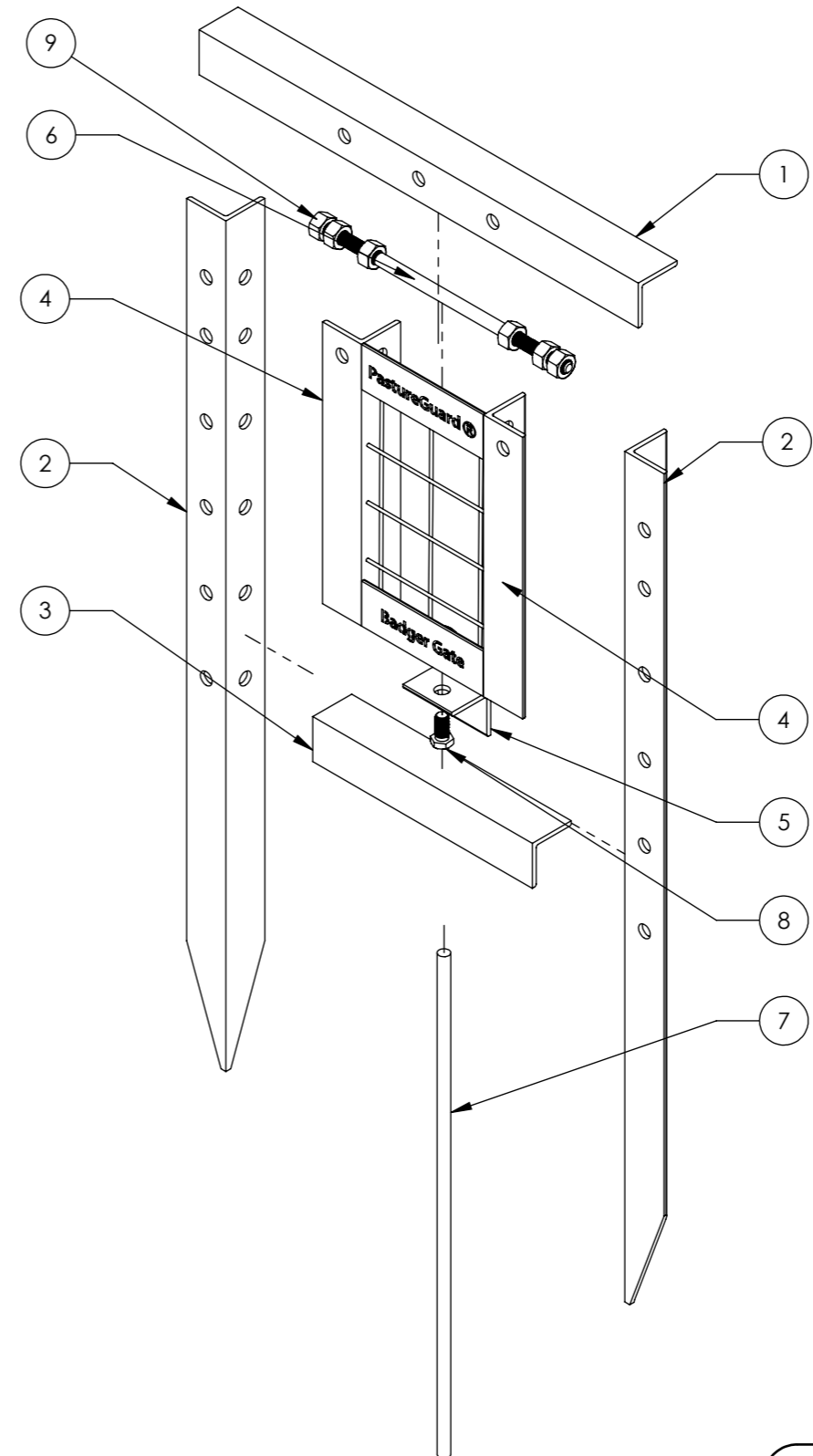

DO NOT SCALE DRAWING

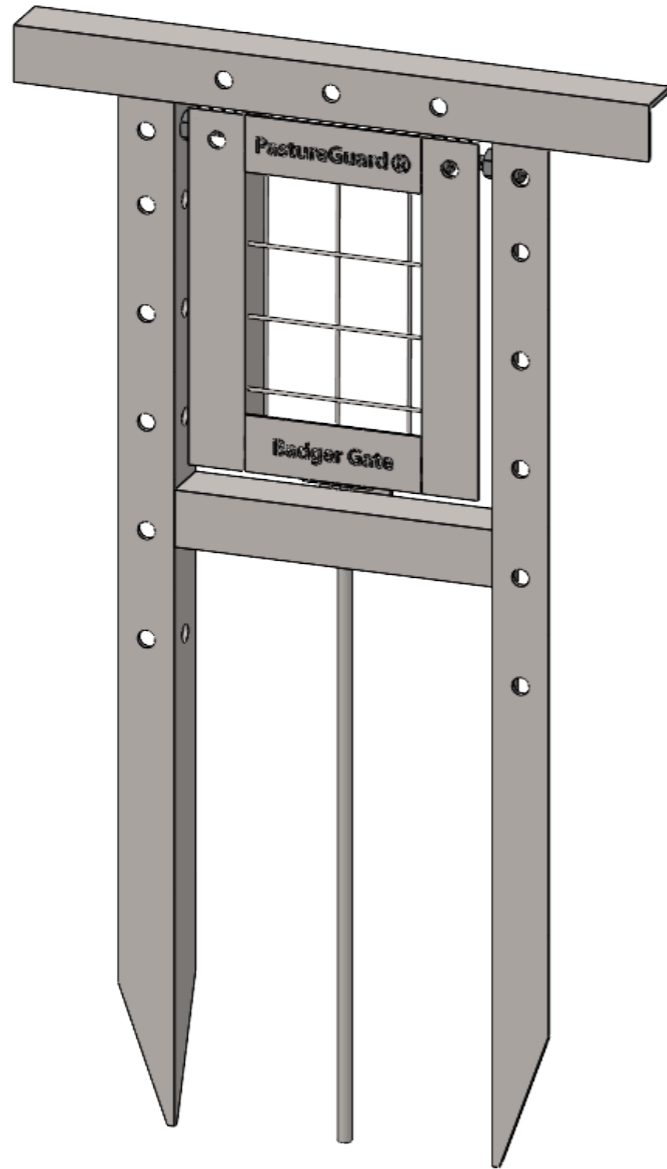

- Notes:**
1. Hot dip galvanised (BS1461)
 2. Simple operation (one or two way)
 3. Comprised of strong 40 x 40 x 4 RSA
 4. 10mm Solid bar for ground anchor
 5. Total 15x Ø 12mm holes allowing for netting or line wire fixings
 6. Gate panel weight: 1.8kg
 7. Opening size: 225mm x 270mm (approx)

Item	Component Name	Qty
1	FABR-BADGER-0100 - FRAME TOP CROSS RSA 40x40x4mm x 450mm LONG	1
2	FABR-BADGER-0110 - FRAME POST RSA 40X40X4mm x 755mm LONG	2
3	FABR-BADGER-0120 - FRAME BOTTOM CROSS RSA 40x40x4mm x 225mm LONG	1
4	BADGER-LEAF-0010 - BADGER GATE 205 X 250 LEAF	1
5	FABR-BADGER-0300 - LOCKING CLIP RSA 40x40x4mm x 50mm LONG	1
6	FABR-BADGER-0310 - HINGE BAR M10 THREADED ENDS 260mm	1
7	FABR-BADGER-0320 - GROUND BAR 10 DIA ROD 445mm LONG	1
8	ACCS-GEN-0020 HEX HEAD BOLT M10 X 20mm	1
9	RAPI-SHIELD-0050- M10 HEX NUT	7

REV	DESCRIPTION	DATE

NAME	DATE	 AGRI-PASTURE-5200
DRAWN	A.T	
APVD	19/02/2026	

Tolerance	0 - 50mm	± 0.2mm
	> 50 - 500mm	± 1mm
	>1000mm	± 3mm

Material: Steel	TITLE: PASTUREGUARD™ BADGER GATE 450mm X 759mm	REV: A
WEIGHT: 7.3kg	SCALE: 1:5	SHEET 1 OF 2

DO NOT SCALE DRAWING

Notes:

1. Hot dip galvanised (BS1461)
2. Simple operation (one or two way)
3. Comprised of strong 40 x 40 x 4 RSA
4. 10mm Solid bar for ground anchor
5. Total 15x Ø10mm holes allowing for netting or line wire fixings
6. Gate panel weight: 1.8kg
7. Opening size: 225mm x 270mm (approx)

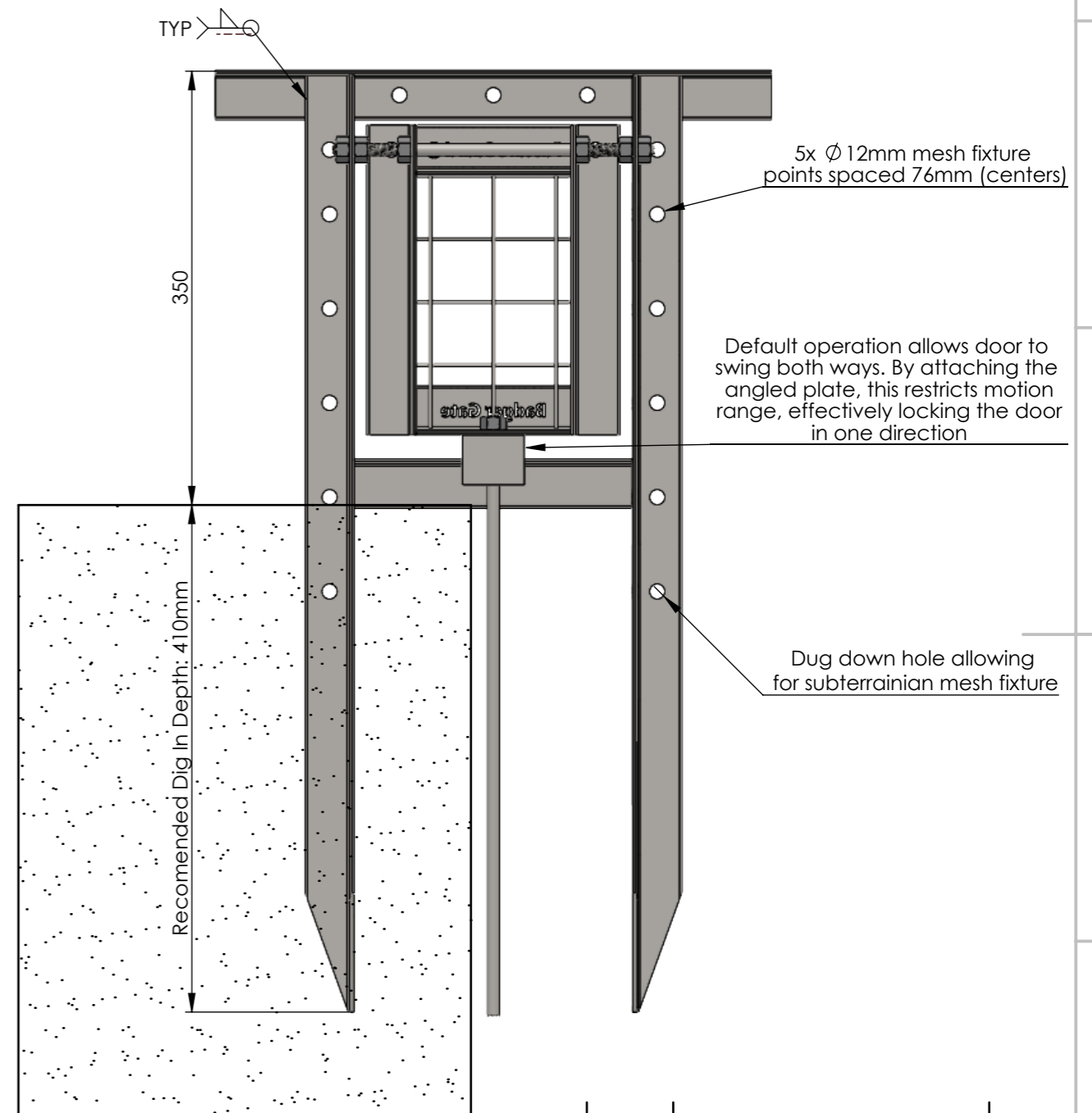
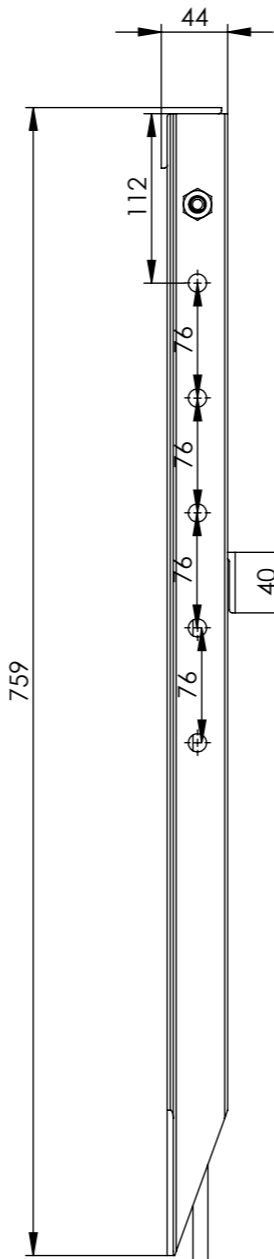
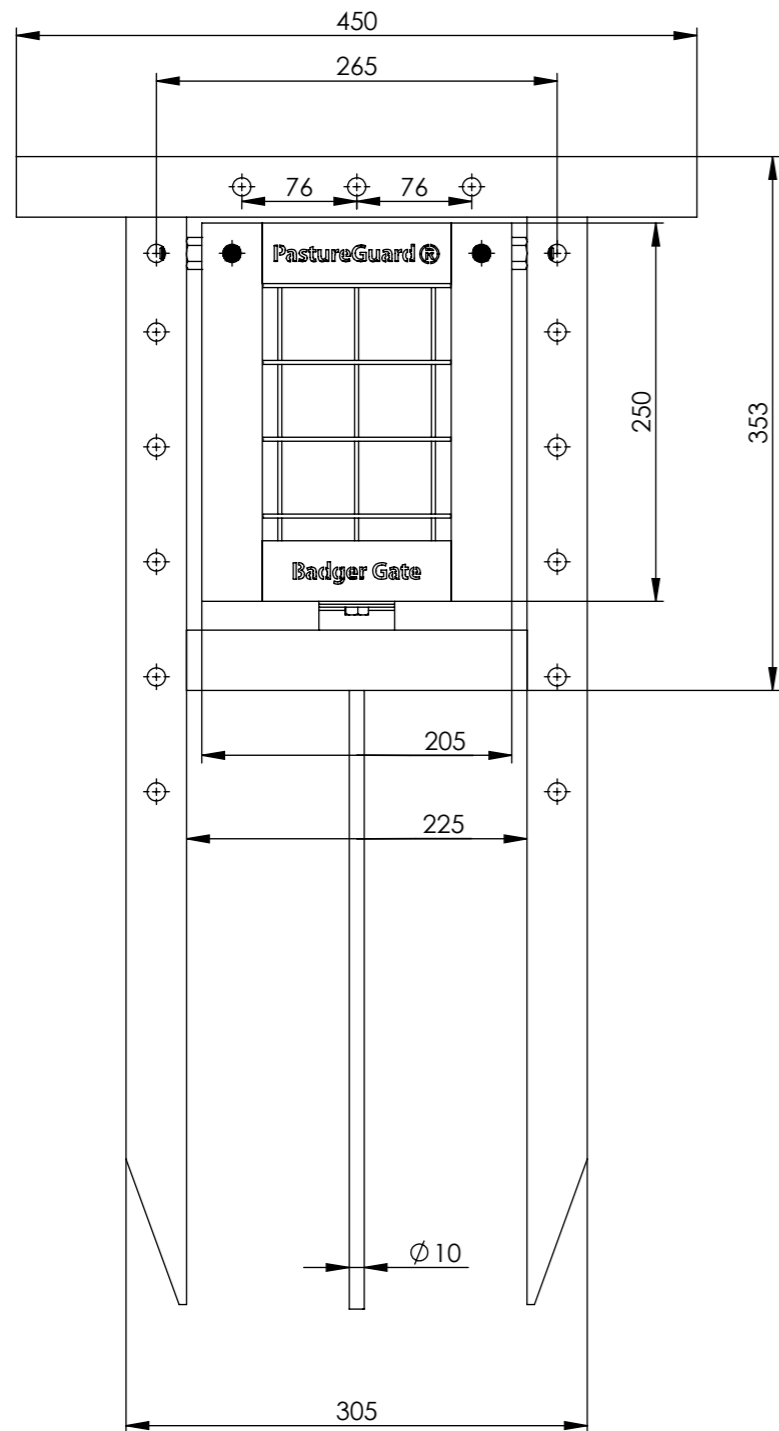
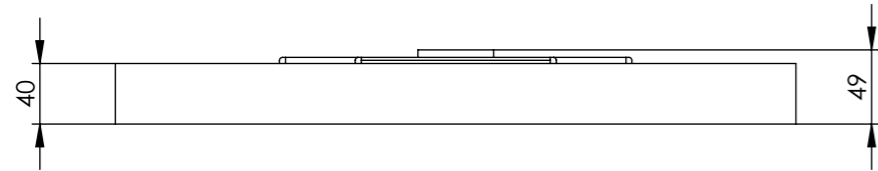

REV	DESCRIPTION	DATE

NAME	DATE	
DRAWN A.T	19/02/2026	
APVD		SKU:
Tolerance	0 - 50mm ± 0.2mm	AGRI-PASTURE-5200
	> 50 - 500mm ± 1mm	
	> 1000mm ± 3mm	
Third Angle Projection		TITLE:
Material: Steel	PASTUREGUARD™ BADGER GATE 450mm X 759mm	
WEIGHT: 7.3kg	SCALE: 1:5	REV A
SHEET 2 OF 2		A3