

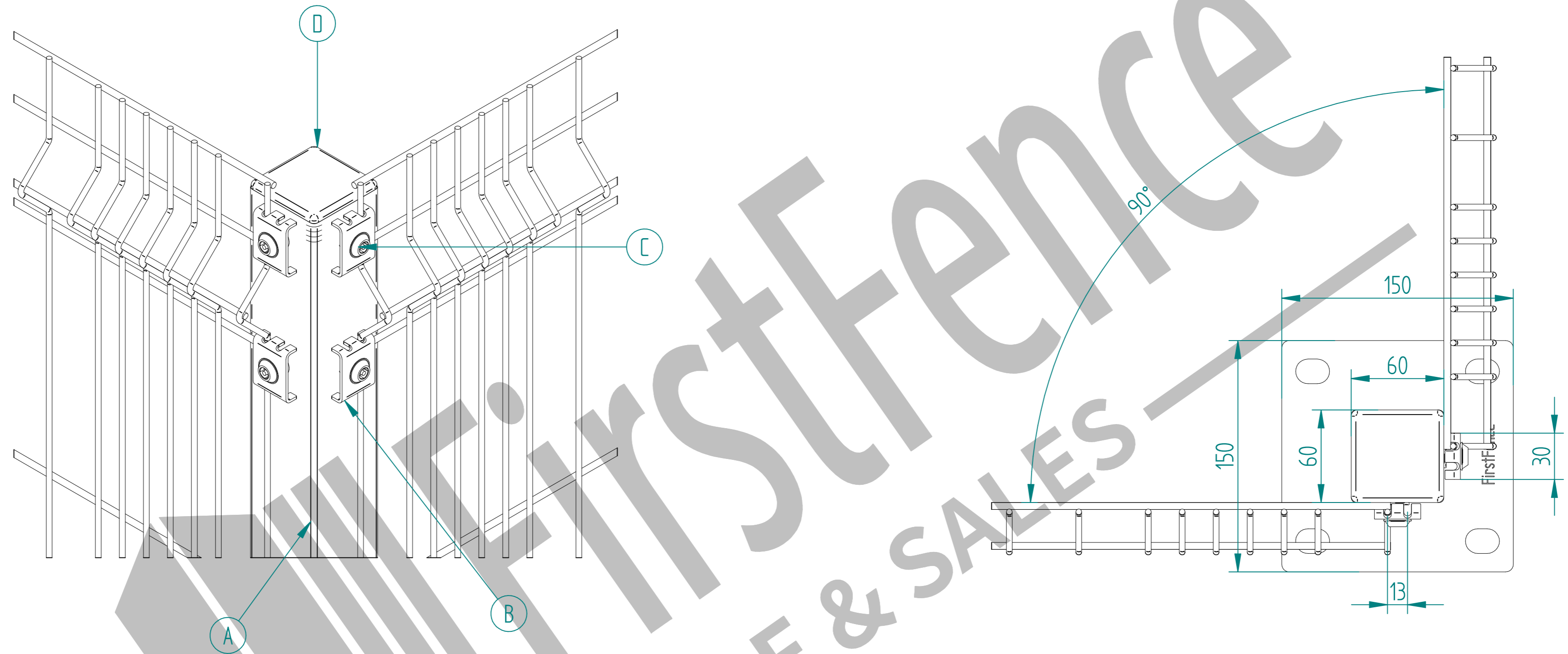

2.4m HIGH BOLT DOWN 60x60 CORNER POST KIT (STRIPE MESH)



Item	Component Name	Quantity
A	MESH-POS-9152 - 2.4m HIGH BOLT DOWN 60X60 CORNER POST	1
B	ACCES-MSH-0001 - UNIVERSAL MESH FENCING BLACK FIXING CLIPS	16
C	ACCES-MSH-0050 - M8 x 40mm MESH SECURITY BOLT	16
D	ACCES-RIB-0003 - 60x60 BLACK RIBBED INSERTS	1

NAME	DATE	TITLE
LT	17/08/20	MESH-KIT-9152 - 2.4m HIGH BOLT DOWN 60X60 CORNER POST KIT (STRIPE MESH)
TOLERANCE ± 2mm Unless Stated Otherwise		 First Fence Ltd, Kiln Way, Swadlincote, Derbyshire, DE11 8EA 01283 512 111 sales@firstfence.co.uk
 3RD ANGLE		NOTE: SHOULD ANY DISCREPANCIES BE FOUND WITH THIS DRAWING, PLEASE INFORM FIRSTFENCE. COPYRIGHT OF THIS DRAWING IS OWNED BY FIRSTFENCE LIMITED. SIZE A2 WEIGHT: N/A
		REV A

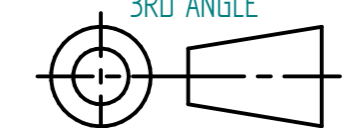
2.4m HIGH BOLT DOWN 60X60 CORNER POST

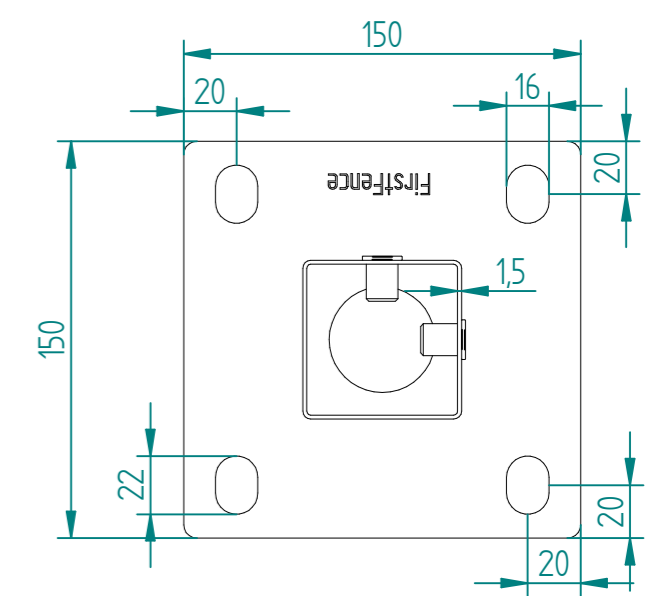
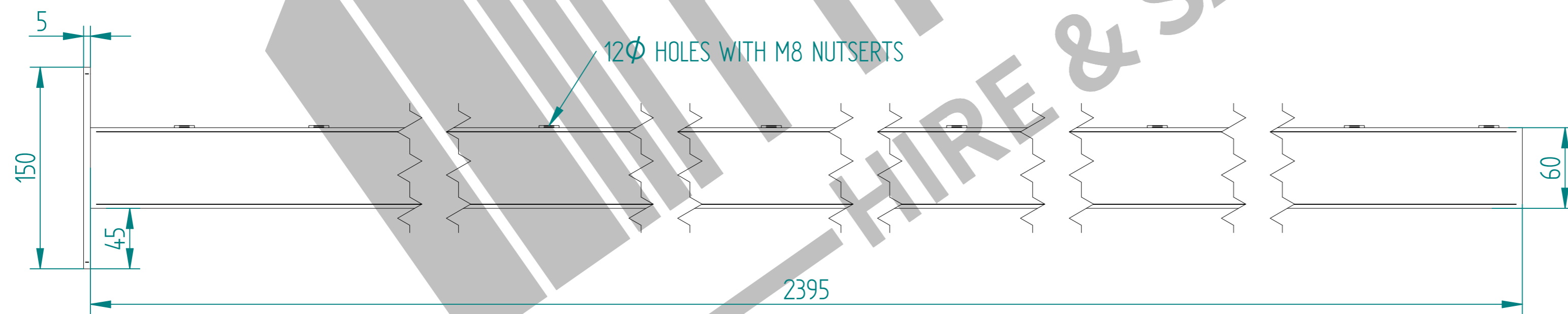
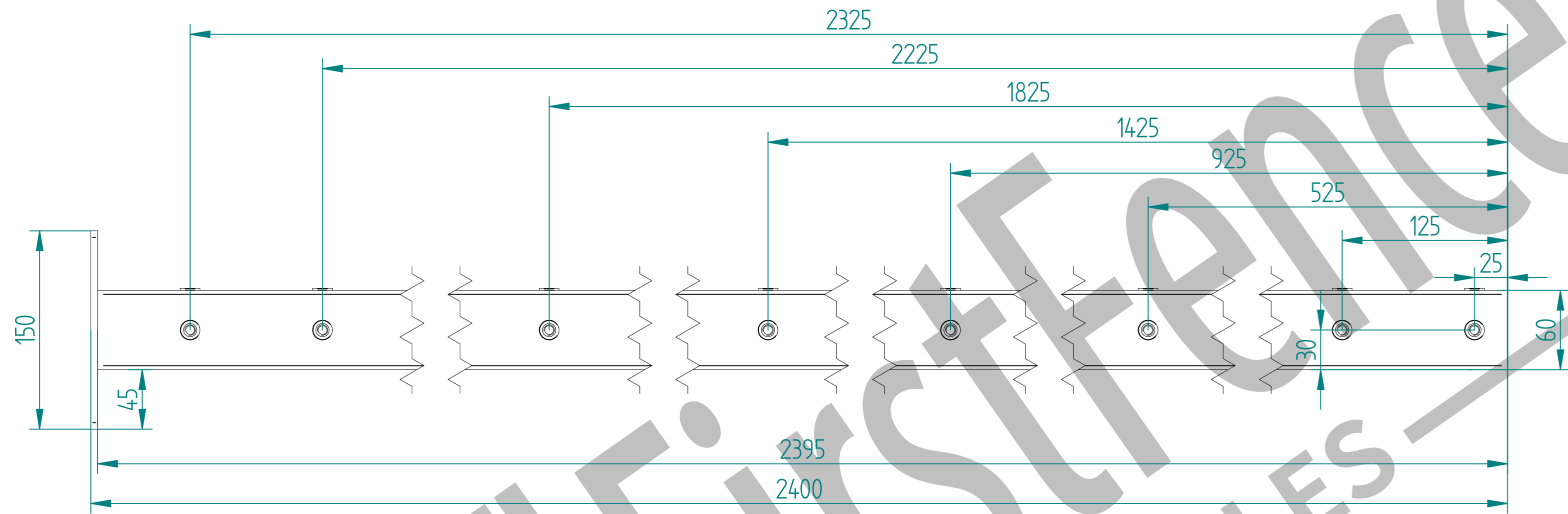

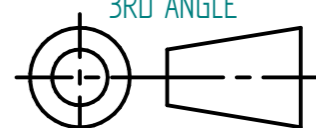
DRAWN		NAME	DATE	TITLE	
DRAWN		LT	17/08/20	2.4m HIGH BOLT DOWN 60X60 CORNER POST	
TOLERANCE		± 2mm Unless Stated Otherwise		 First Fence Ltd, Kiln Way, Swadlincote, Derbyshire, DE11 8EA 01283 512 111 sales@firstfence.co.uk	
3RD ANGLE				NOTE: SHOULD ANY DISCREPANCIES BE FOUND WITH THIS DRAWING, PLEASE INFORM FIRSTFENCE. COPYRIGHT OF THIS DRAWING IS OWNED BY FIRSTFENCE LIMITED.	REV A
SIZE A2		WEIGHT: 7.4 kg		SHEET 2 OF 2	